



Mounting options

There are three basic methods of mounting hinges

Full overlay

In this configuration, the door is positioned in front of a side wall of the cabinet. The reveal at one side is such that the door can be opened safely.

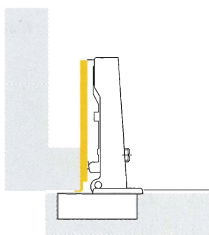

Half overlay

In this configuration, two doors are positioned in front of the middle wall of a cabinet. The distance between the doors is the total required reveal.

The door overlay is reduced which necessitates the use of cranked hinges.

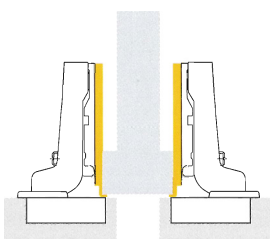

Inset

In this configuration, the door is positioned inside the side wall of the cabinet. A reveal is required for opening the door. This configuration necessitates the use of heavily cranked hinges.

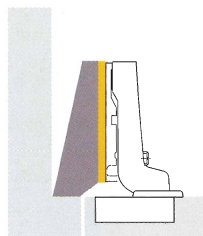

Cup distance C

The cup distance C is the distance between the edge of the door and the edge of the cup hole. The maximum cup distance depends on the hinge in question.

The larger the cup distance, the smaller the required minimum reveal.

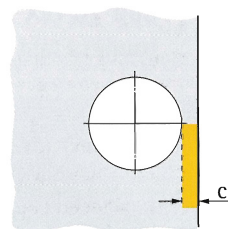

Overlay (Door overlay)

The overlay is the distance by which the door projects over the cabinet front.

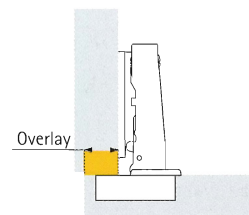

Reveal

The reveal is the distance between the outer edge of the door and the outer side of the cabinet (full overlay), the distance between two doors (half overlay), the distance between the outer edge of the door and the inner side of the cabinet (inset).

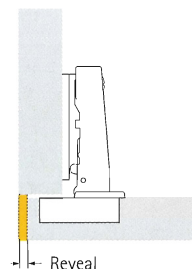

Number of hinges per door:

Door width, door height, door weight plus material quality of the door are key factors for determining the required number of hinges. In practice, these factors are very variable. The numbers given in the diagram are for reference only. A trial mounting is recommended if in doubt.

For stability, the distance between hinges should be chosen as large as possible.

X = distance between two hinges

(Reference values for 19 mm thick chipboard with a density of 750 kg/m³)

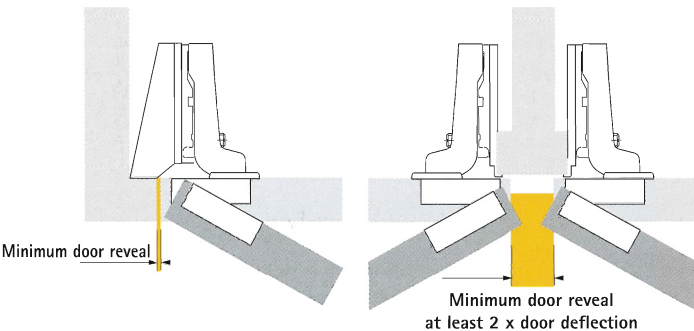

Minimum door reveal

The minimum reveal, also called door deflection, is the space required for opening a door.

The amount of reveal depends on the cup distance C, the door thickness and the hinge type. Chamfered door edges reduce the reveal required.

The required minimum reveal can be derived from the table provided for each hinge.

Minimum door reveal for half overlay

For half overlay configurations, the total reveal between the doors must be chosen to correspond to twice the door reveal. Both doors can then be opened at the same time.

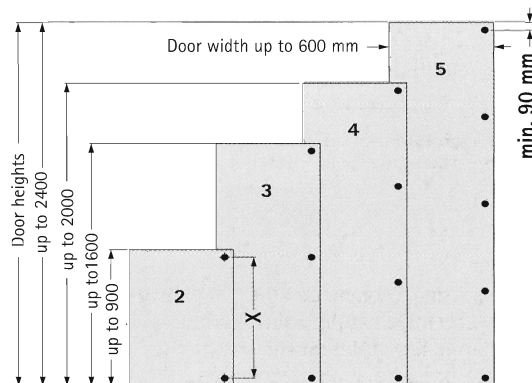

Technical information

Intermat Fast-assembly hinges



Distance

Mounting plates are available in various thicknesses with an effective height characterized by the value of the distance.

Starting point for calculating the required distance is the selected hinge with defined door overlay.

Using planned cup distance and door thickness, first read the required reveal value from the table. If this value is too large for the desired overlay, it can be reduced either by increasing the cup distance C or by chamfering the door edge.

Once the door reveal and cup distance C have been defined, the mounting plate distance can be derived from the table.

If the distance value deviates from the actual mounting plate distance shown in the catalogue, the difference can be compensated by turning the overlay adjustment screw.

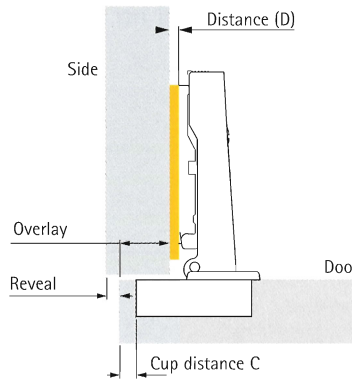

Example: Intermat 9943 - Full overlay

Fixed sizes **Overlay** 14,5 mm
Cup distance 4,5 mm

The table shows a **Distance (D)** of 3 mm

D	Overlay mm				
0	16	17	17,5	18	19
1,5	14,5	15,5	16	16,5	17,5
3	13	14	14,5	15	16
4,5	11,5	12,5	13	13,5	14,5
8	8	9	9,5	10	11
	3	4	4,5	5	6

Cup distance C mm

Door adjustment

Overlay adjustment

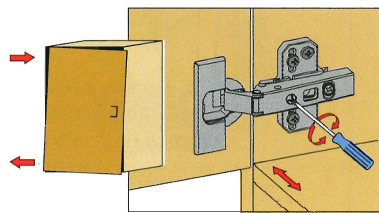

Turn screw clockwise:
Door overlay decreases (-).
Turn screw anticlockwise:
Door overlay increases (+).

Depth adjustment

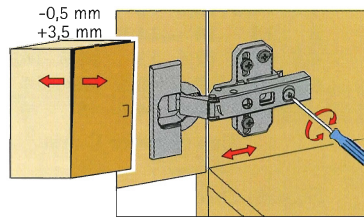

Direct, variable depth adjustment
with the eccentric screw

Height adjustment

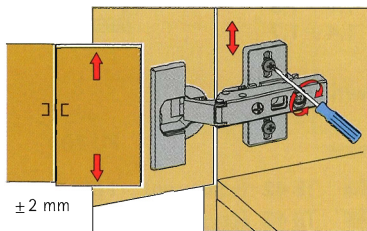

Using height-adjustable mounting plates
makes it possible to align the exact door height.

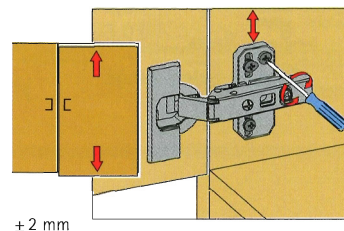

Direct, variable height adjustment
with eccentric screw

When using Ecomat and linear mounting plates with eccentric height adjustment, the hinge has to be moved out of the way in order to adjust the height.

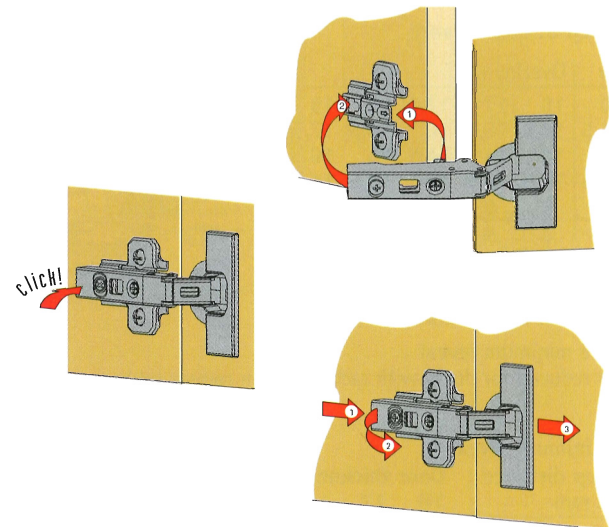

Intermat Snap-on assembly, disassembly

Characteristic for Intermat hinges is the ergonomical **snap-on assembly**. The hinge is slipped into the front of the mounting plate (1), then a light finger pressure and the hinge arm latches onto the mounting plate (2) with an audible click.

The hinge arm is now securely clamped, via five points, with zero play.

Doors are clipped on **zipper style from top to bottom** - the top hinge alone is capable of taking the total weight of the door.

Disassembly is carried out in the opposite direction **from bottom to top**.

The hinge is unlatched by pressing lightly on latch (1) which is hidden under the side arm for security reasons.

In one movement, the hinge arm is lifted off the mounting plate (2) and the door is removed from the cabinet (3).

Technical information

Determine construction



Face Frame

Step 1: Determine cabinet construction

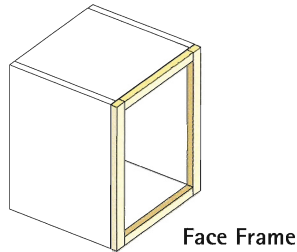

Step 2: Determine mounting option

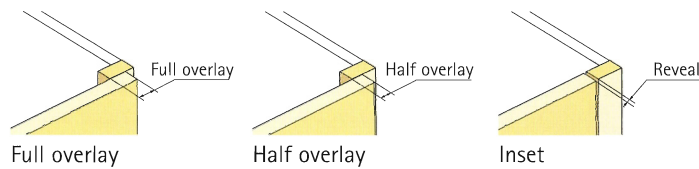

Step 3: Cup distance

D	Overlay mm				
0	16	17	17,5	18	19
1,5	14,5	15,5	16	16,5	17,5
3	13	14	14,5	15	16
4,5	11,5	12,5	13	13,5	14,5
8	8	9	9,5	10	11
	3	4	4,5	5	6

Cup distance C mm

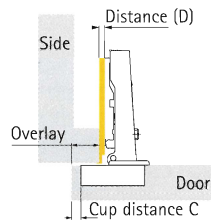

Step 4: Check minimum reveal

The minimum reveal is reduced for doors with radii: 1 mm radius: table entry – 0,4 mm
3 mm radius: table entry – 1,2 mm

Minimum reveal

Cup distance C mm	Door thickness mm				
	16	17	18	19	20
3	0,6	0,8	1,1	1,5	1,9
4	0,5	0,7	1,0	1,4	1,8
4,5	0,5	0,7	1,0	1,4	1,8
5	0,5	0,7	1,0	1,4	1,8
6	0,5	0,7	1,0	1,4	1,7

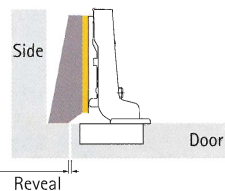

Frameless

Step 1: Determine cabinet construction

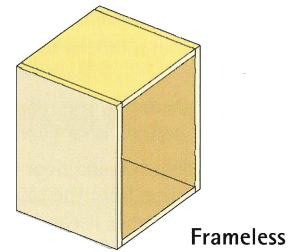

Step 2: Determine mounting option

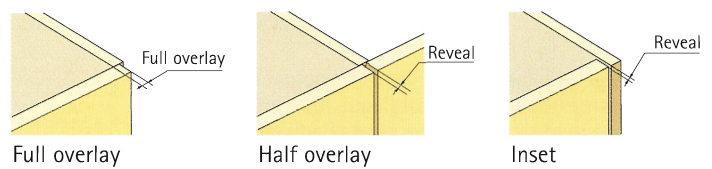

Step 3: Cup distance

D	Overlay mm				
0	16	17	17,5	18	19
1,5	14,5	15,5	16	16,5	17,5
3	13	14	14,5	15	16
4,5	11,5	12,5	13	13,5	14,5
8	8	9	9,5	10	11
	3	4	4,5	5	6

Cup distance C mm

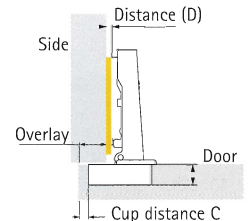

Step 4: Check minimum reveal

The minimum reveal is reduced for doors with radii: 1 mm radius: table entry – 0,4 mm
3 mm radius: table entry – 1,2 mm

Minimum reveal

Cup distance C mm	Door thickness mm				
	16	17	18	19	20
3	0,6	0,8	1,1	1,5	1,9
4	0,5	0,7	1,0	1,4	1,8
4,5	0,5	0,7	1,0	1,4	1,8
5	0,5	0,7	1,0	1,4	1,8
6	0,5	0,7	1,0	1,4	1,7

